

Feingewindeschrauben Fine-Thread Screws

FGS

- Stellbereiche zwischen 3 mm und 35 mm, je nach Ausführung
- Spindelsteigung 0,25 mm oder 0,35 mm
- travel range between 3 mm and 35 mm, depending on type
- spindle pitch 0.25 mm or 0.35 mm



9012.0166 / 16.02.2021



Die OWIS® Feingewindeschrauben FGS haben präzise gefertigte Spindeln, in die eine gehärtete Stahlkugel als Druckstück eingelassen ist. Damit eignen sich diese Feingewindeschrauben vor allem als hochauflösende Stellantriebe.

Die Feingewindeschrauben unterscheiden sich in der Steigung, im Einschraubgewinde sowie den Stellwegen zwischen 3 und 35 mm.

Speziell für Anwendungen in beengten Einbauverhältnissen wurden die Feingewinde-Stiftschrauben mit Innensechskant FGS 6-4 entwickelt. Ihr Stellweg beträgt 4 mm.

The OWIS® FGS fine-thread screws have precisely finished spindles. As thrust piece a hardened steel ball is embedded in the spindle. Thus, these screws are particularly used as precise actuators.

The fine-thread screws differ in the pitch, the fastening thread as well as in the travels between 3 and 35 mm.

For applications with limited space, the fine-thread grub screws with hexagon socket FGS 6-4 were designed. Their travel range is 4 mm.

Bestellangaben/Ordering Information

Feingewindeschrauben/fine-thread screws

		Typ/type	Bestell-Nr./part no.
3 mm Stellweg, Einschraubgewinde M6x0,5	3 mm travel, mounting thread M6x0.5	FGS6-3	91.142.1603
7,5 mm Stellweg, Einschraubgewinde M6x0,5	7.5 mm travel, mounting thread M6x0.5	FGS6-7.5	91.142.1607
10 mm Stellweg, Einschraubgewinde M6x0,5	10 mm travel, mounting thread M6x0.5	FGS6-10	91.142.1610
12,5 mm Stellweg, Einschraubgewinde M6x0,5	12.5 mm travel, mounting thread M6x0.5	FGS6-12.5	91.142.1612
15,5 mm Stellweg, Einschraubgewinde M6x0,5	15.5 mm travel, mounting thread M6x0.5	FGS6-15.5	91.142.1615
18 mm Stellweg, Einschraubgewinde M6x0,5	18 mm travel, mounting thread M6x0.5	FGS6-18	91.142.1618
7,5 mm Stellweg, Einschraubgewinde M6	7.5 mm travel, mounting thread M6	FGS7-7.5	91.142.0607
10 mm Stellweg, Einschraubgewinde M6	10 mm travel, mounting thread M6	FGS7-10	91.142.0610
15,5 mm Stellweg, Einschraubgewinde M6	15.5 mm travel, mounting thread M6	FGS7-15.5	91.142.0615
17 mm Stellweg, Einschraubgewinde M9x0,5	17 mm travel, mounting thread M9x0.5	FGS9-17	91.163.1917
35 mm Stellweg, Einschraubgewinde M9x0,5	35 mm travel, mounting thread M9x0.5	FGS9-35-DK	91.163.1935
17 mm Stellweg, Einschraubgewinde M10	17 mm travel, mounting thread M10	FGS10-17	91.163.1017
35 mm Stellweg, Einschraubgewinde M10	35 mm travel, mounting thread M10	FGS10-35-DK	91.163.1035
4 mm Stellweg, Einschraubgewinde M6x0,5 (Stiftschraube)	4 mm travel, mounting thread M6x0.5 (grub screw)	FGS6-4-oR	91.143.1607

Zubehör/Accessories

Kontermutter M4x0,25	counter nut M4x0,25	KM-4-25	91.142.0001
Kontermutter M6x0,35	counter nut M6x0,35	KM-6-35	91.163.0001

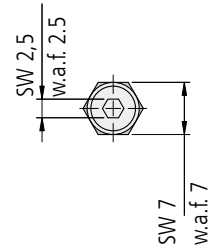
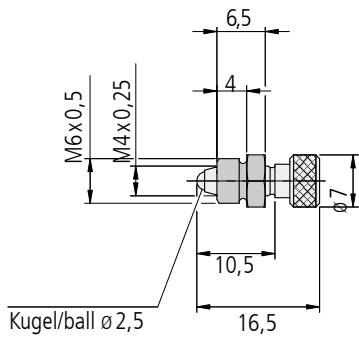

3 mm Stellweg, Einschraubgewinde M6x0,5	3 mm travel, mounting thread M6x0.5	Typ/type FGS6-3	Bestell-Nr./part no. 91.142.1603
---	-------------------------------------	--------------------	-------------------------------------

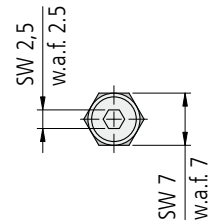
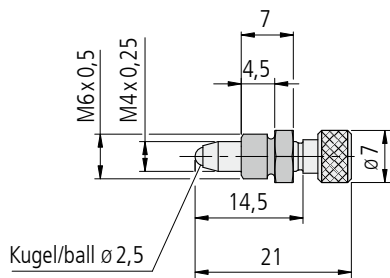

7,5 mm Stellweg, Einschraubgewinde M6x0,5	7.5 mm travel, mounting thread M6x0.5	Typ/type FGS6-7.5	Bestell-Nr./part no. 91.142.1607
---	---------------------------------------	----------------------	-------------------------------------

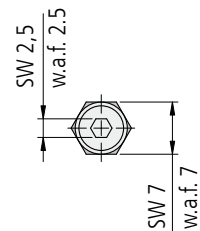
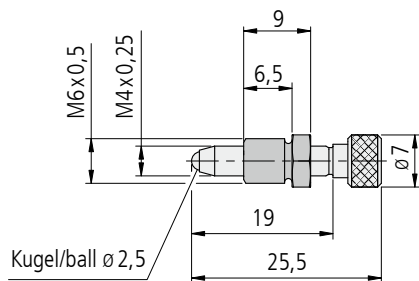

10 mm Stellweg, Einschraubgewinde M6x0,5	10 mm travel, mounting thread M6x0.5	Typ/type FGS6-10	Bestell-Nr./part no. 91.142.1610
--	--------------------------------------	---------------------	-------------------------------------

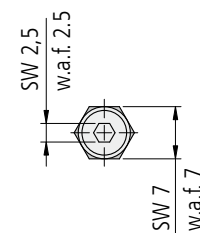
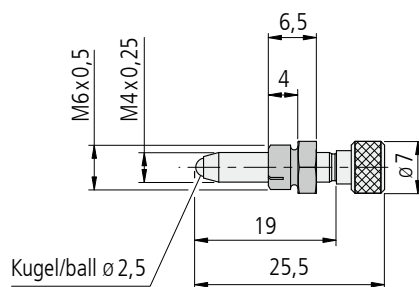

12,5 mm Stellweg, Einschraubgewinde M6x0,5	12.5 mm travel, mounting thread M6x0.5	Typ/type FGS6-12.5	Bestell-Nr./part no. 91.142.1612
--	--	-----------------------	-------------------------------------

FGS6-15.5

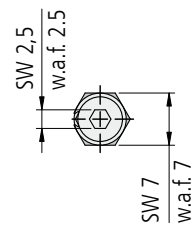
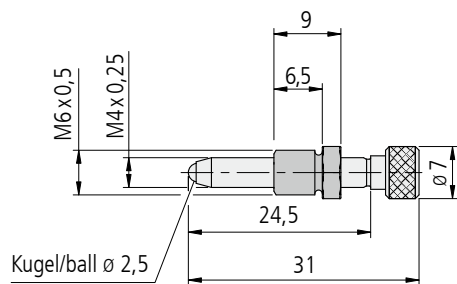

	Typ/type	Bestell-Nr./part no.
15,5 mm Stellweg, Einschraubgewinde M6x0,5 15.5mm travel, mounting thread M6x0.5	FGS6-15.5	91.142.1615

FGS6-18

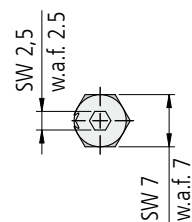
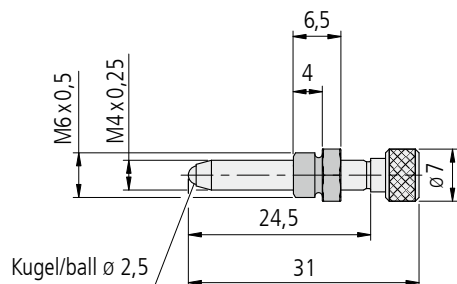

	Typ/type	Bestell-Nr./part no.
18 mm Stellweg, Einschraubgewinde M6x0,5 18mm travel, mounting thread M6x0.5	FGS6-18	91.142.1618

FGS7-7.5

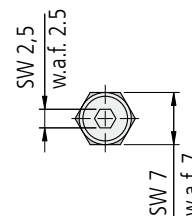
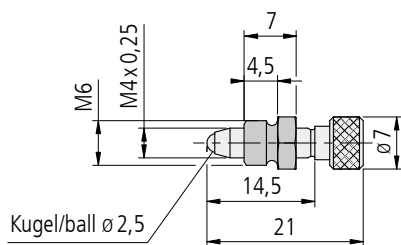

	Typ/type	Bestell-Nr./part no.
7,5 mm Stellweg, Einschraubgewinde M6 7.5 mm travel, mounting thread M6	FGS7-7.5	91.142.0607

FGS7-10

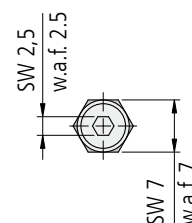
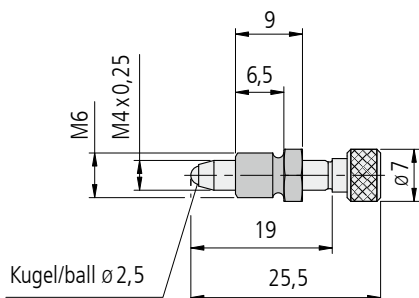

	Typ/type	Bestell-Nr./part no.
10 mm Stellweg, Einschraubgewinde M6 10 mm travel, mounting thread M6	FGS7-10	91.142.0610

FGS 7-15.5

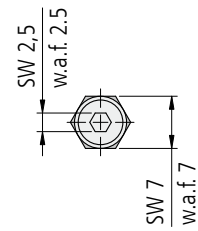
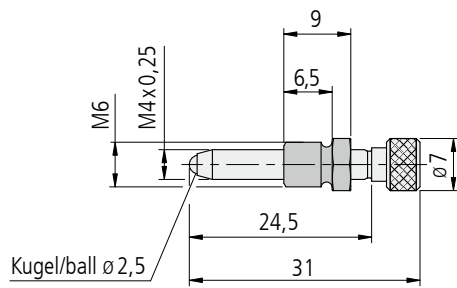

		Typ/type	Bestell-Nr./part no.
15,5 mm Stellweg, Einschraubgewinde M6	15.5 mm travel, mounting thread M6	FGS 7-15.5	91.142.0615

FGS 9-17

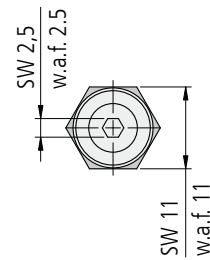
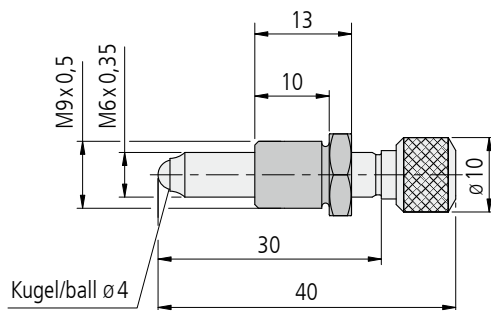

		Typ/type	Bestell-Nr./part no.
17 mm Stellweg, Einschraubgewinde M9x0,5	17 mm travel, mounting thread M9x0.5	FGS 9-17	91.163.1917

FGS 9-35-DK

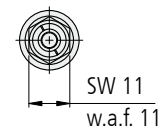
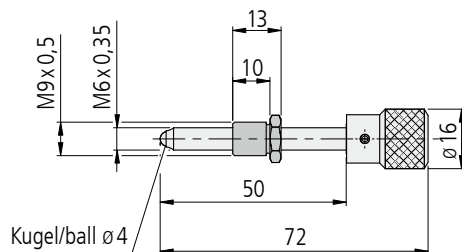

		Typ/type	Bestell-Nr./part no.
35 mm Stellweg, Einschraubgewinde M9x0,5	35 mm travel, mounting thread M9x0.5	FGS 9-35-DK	91.163.1935

FGS 10-17

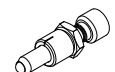
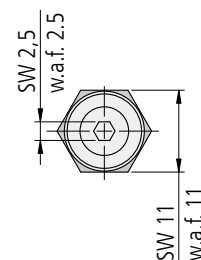
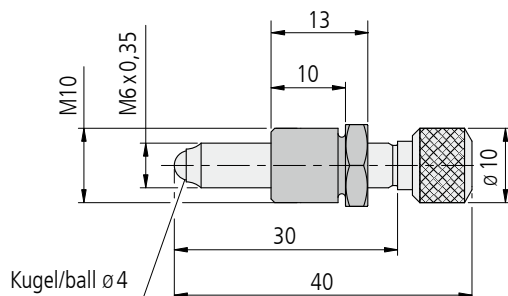

		Typ/type	Bestell-Nr./part no.
17 mm Stellweg, Einschraubgewinde M10	17 mm travel, mounting thread M10	FGS 10-17	91.163.1017

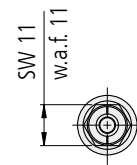
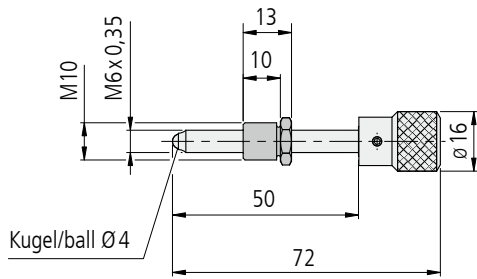
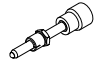

35 mm Stellweg, Einschraubgewinde M10	35 mm travel, mounting thread M10	Typ/type FGS 10-35-DK	Bestell-Nr./part no. 91.163.1035
---------------------------------------	-----------------------------------	--------------------------	-------------------------------------

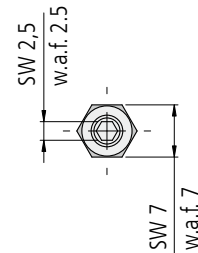
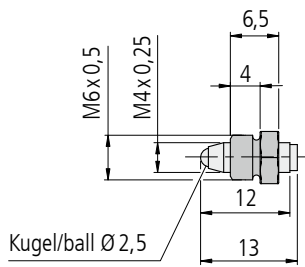

4 mm Stellweg, Einschraubgewinde M6x0,5 (Stiftschraube)	4 mm travel, mounting thread M6x0.5 (grub screw)	Typ/type FGS 6-4-oR	Bestell-Nr./part no. 91.143.1607
--	---	------------------------	-------------------------------------

Technische Daten/Technical Data FGS

		FGS 6	FGS 7	FGS 9	FGS 10	
Stellweg	travel	3 bis/up to 15,5	7,5 bis/up to 15,5	17/35	17/35	mm
max. zulässige Axialkraft	max. allowable axial force	30	30	50	50	N
Spindelsteigung	spindle pitch	0,25	0,25	0,35	0,35	mm
Befestigungsgewinde	fixing thread	M6x0,5	M6	M9x0,5	M10	
Gewicht	weight	5	5	16/25	16/26	g

