

Hochpräzisions-Lineartische mit Messsystem High-Precision Linear Stages with measuring system

LIMES 84N-IMS



9012.0356 / 27.08.2021

- | | |
|---|--|
| <ul style="list-style-type: none">• Stellweg bis 270 mm• verzugsarmes Aluminium• reflexionsarm, schwarz eloxiert• nahezu spielfreier Kugelgewindetrieb• Schlitten mit geschliffenen und korrosionsbeständigen Kugelumlaufführungen• mit integriertem Linearmesssystem• Hall-Effekt- oder mechanische Endschalter• mit Metallabdeckung• 2-Phasen-Schrittmotor oder DC-Motor• mit OWISid | <ul style="list-style-type: none">• travel up to 270 mm• deformation-resistant aluminium• reflection-poor, black anodized• almost backlash-free ball screw• carriage with ground and stainless recirculating ball bearing guides• with integrated linear measuring system• Hall-effect or mechanical limit switches• with metal covering• 2-phase step motor or DC motor• with OWISid |
| Option
– Bremse | option
– brake |

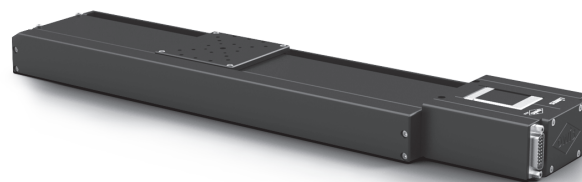

Die Lineartische der Serie LIMES 84N-IMS mit dem integrierten Linearmesssystem zeichnen sich durch eine besonders hohe Genauigkeit für höchste Positionieranforderungen aus. Durch die integrierte Metallabdeckung sowie ihre Eignung für den Dauerbetrieb sind die Lineartische der LIMES 84N-IMS-Serie optimal in der Forschung und Industrie einsetzbar.

Nahezu spielfreie Führungen sorgen für optimalen Lauf sowie für hohe Belastbarkeit.

Durch das integrierte Messsystem ist jederzeit eine genaue Positonsrückmeldung mit höchster Auflösung gewährleistet.

Der hochwertige Antrieb und der vorgespannte Kugelgewindetrieb gewährleisten hochpräzise Vorschubbewegungen sowie hohe Lebensdauer.

Durch die integrierte Metallabdeckung werden die hochwertigen Führungen und der Kugelgewindetrieb geschützt.

Alle Aluminiumteile haben eine hochwertige schwarze Eloxal-Schutzschicht.

The linear stages of the series LIMES 84N-IMS with the integrated linear measuring system are characterized by high precision for highest positioning requirements. Due to the integrated metal covering as well as their suitability for continuous operation, the LIMES 84N-IMS linear stages are the optimal choice for R&D and industrial applications.

The almost backlash-free guides provide optimal motion as well as high load capacity.

The integrated measuring system provides an accurate position feedback with highest resolution at any time.

The high quality drive and the preloaded ball screw ensure high-precision movement as well as a high life time.

The integrated metal covering protects the high-quality guides and ball screw.

All aluminium parts have a top quality black anodized protective coating.

Tragkraft/load capacity



Stellkraft/actuating force

min. →

← max.

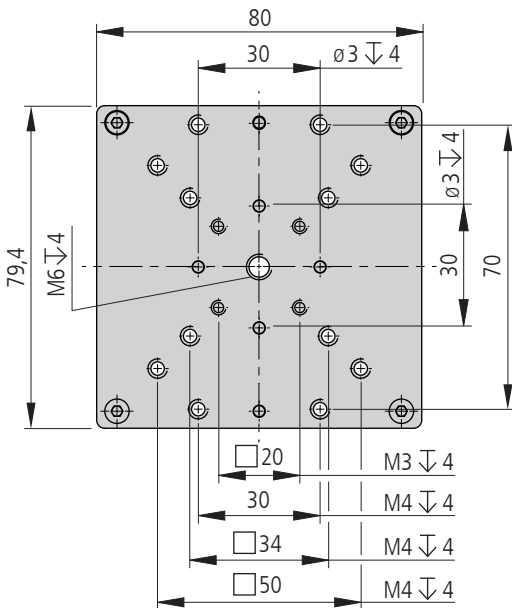
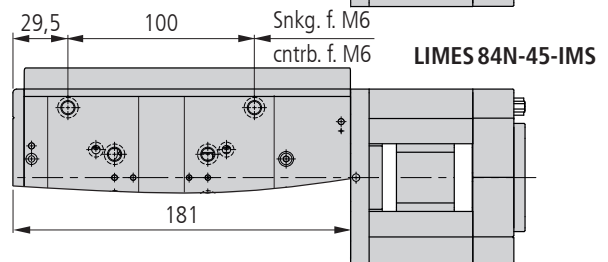
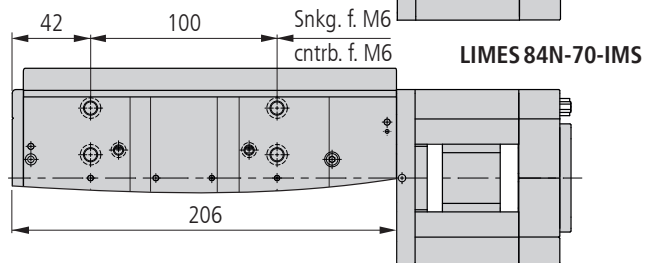
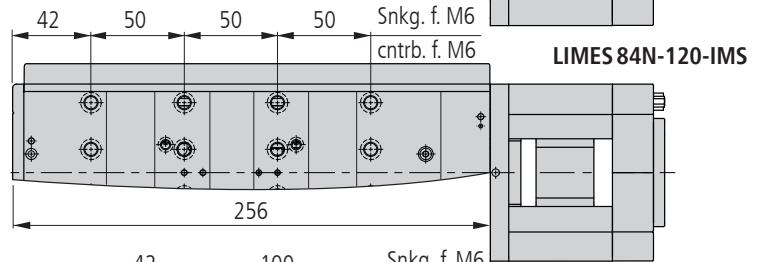
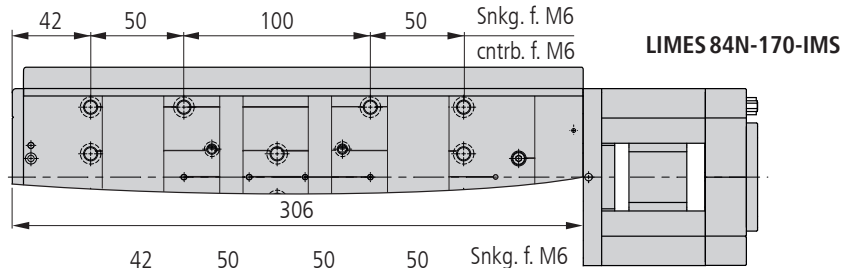
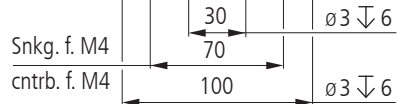
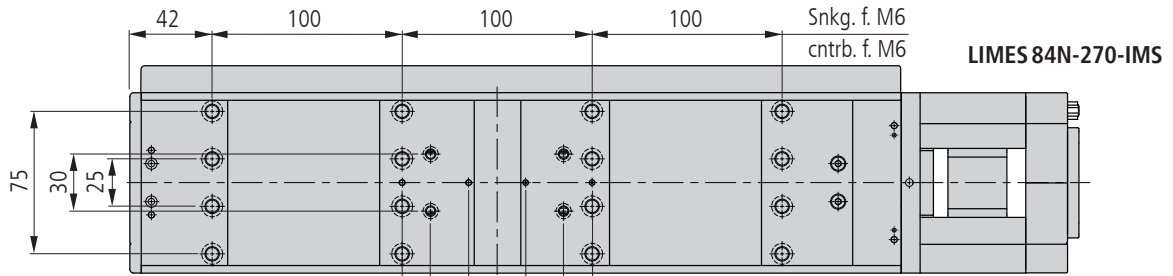
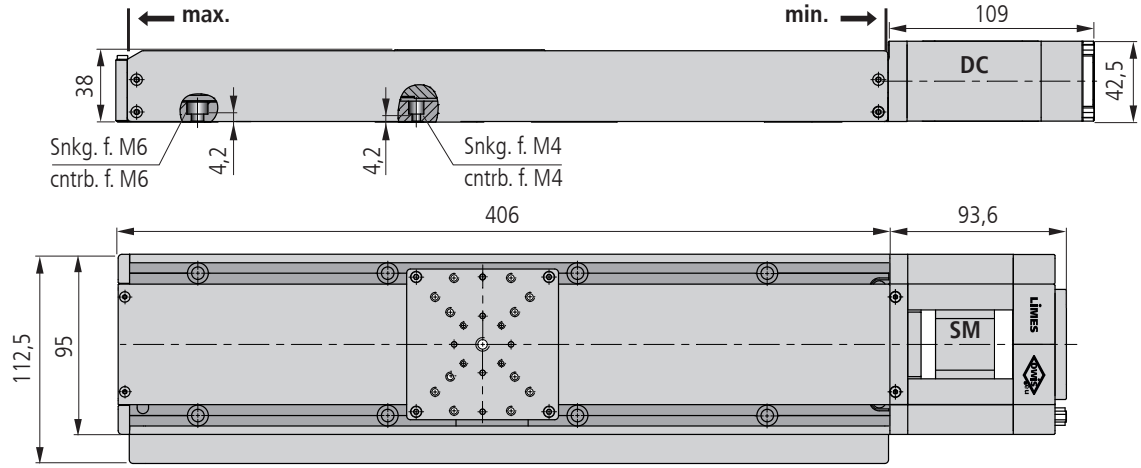

LIMES 84N-XXX-XXXX-IMS

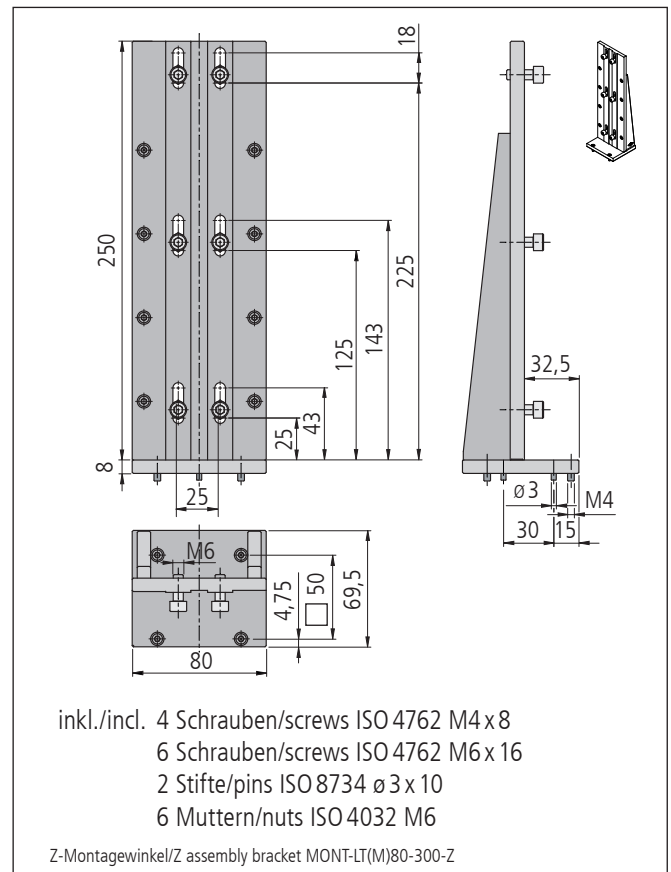
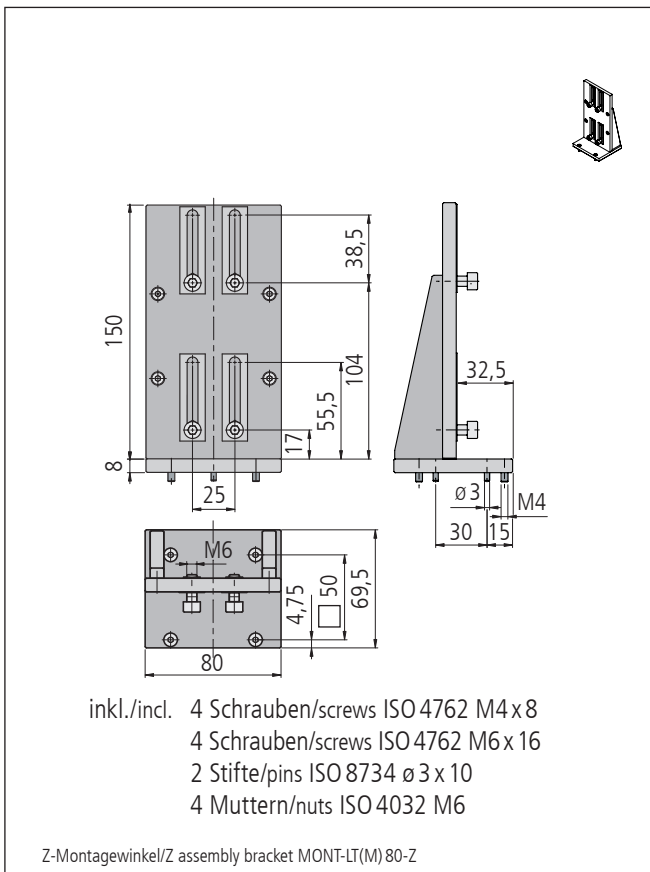
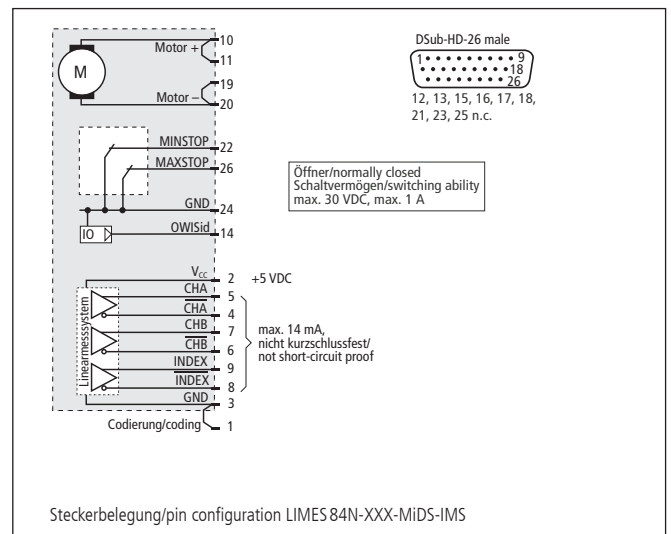
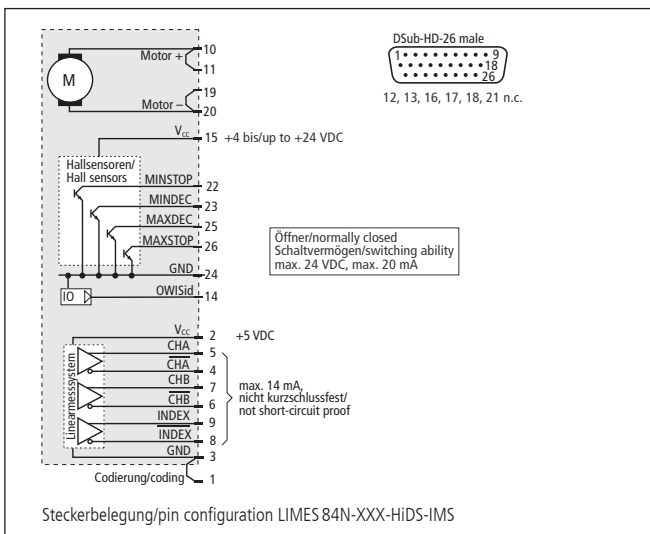
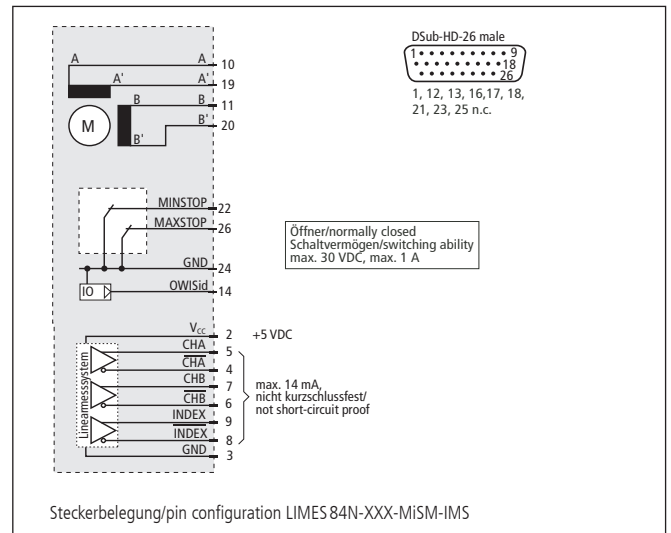
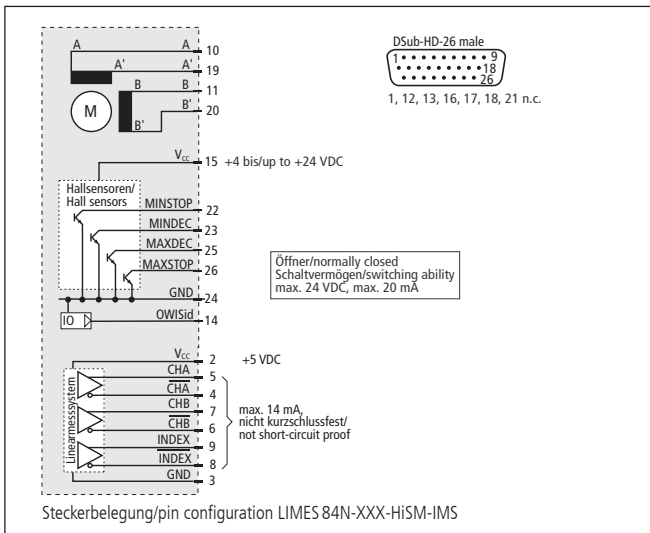

Technische Daten/Technical Data LIMES 84N-IMS (bei 20 °C/@ 20 °C, ohne Last/no load)

		Schrittmotor step motor	DC-Motor DC motor	
Geschwindigkeit	velocity	max. 20		mm/s
Tragkraft	load capacity	max. 150		N
Stellkraft	actuating force	max. 60		N
Kippmoment (Mx, My, Mz)	moment of tilt (Mx, My, Mz)	max. 15		Nm
Spindelsteigung	spindle pitch	1		mm
Wiederholfehler (bidirektional) ⁴⁾	repeatability (bidirectional) ⁴⁾	< 500		nm
Positionierfehler	positioning error	< 16		µm/100mm
Gierwinkel	yaw angle	< 100		µrad
Nickwinkel	pitch angle	< 150		µrad
Höhenschlag	vertical deviation	< 4		µm
Seitenschlag	lateral deviation	< 4		µm
Motorspannung	motor voltage	max. 50	max. 36	V
Motorstrom	motor current	max. 1,5 ¹⁾	max. 2,1	A
Schritte/Impulse pro Motorumdrehung	steps/pulses per motor revolution	200 ²⁾	2000	
Auflösung Linearmesssystem (IMS)	resolution linear measuring systems (IMS)		50	nm
Skalenteilung (IMS)	graduation of scale (IMS)		20	µm
Digitale Ausgangssignale (IMS) ⁵⁾	digital output signals (IMS) ⁵⁾		A-quad-B ⁶⁾	
Spannung (IMS)	voltage (IMS)		5 ± 5%	VDC
max. Stromstärke (IMS)	max. current (IMS)		160	mA
Empfohlener Terminierungswiderstand (IMS)	recommended termination resistor (IMS)		120	Ω
Gewicht	weight		~ 2,2 - 3,4	kg
Betriebstemperatur ³⁾	ambient operating temperatur ³⁾		+ 10 bis/up to + 50	°C
Lagerungstemperatur ³⁾	storage temperature ³⁾		- 20 bis/up to + 70	°C

¹⁾ pro Phase/per phase ²⁾ im Vollschrittbetrieb/in full-step mode ³⁾ ohne Betauung/without condensation ⁴⁾ mit Nachlaufregelung/with follow up control
⁵⁾ RS-422 kompatibel/RS-422 compatible ⁶⁾ Indexpulsebreite/ index pulse width: 1 LSB

Alle technischen Daten sind abhängig von Einbaulage, Anwendung und eingesetzter Steuerung.
All technical data depend on orientation, application and used control unit.

Bestellangaben/Ordering Information

Hochpräzisions-Lineartische/high-precision linear stages

mit Schrittmotor/with step motor	mit Hall-Effekt-Endschaltern with Hall-effect limit switches		mit mechanischen Endschaltern with mechanical limit switches	
	Typ/type	Bestell-Nr./part no.	Typ/type	Bestell-Nr./part no.
45 mm Stellweg/travel	LIMES 84N-45-HiSM-IMS	41.A89.04AVM	LIMES 84N-45-MiSM-IMS	41.A89.04BVM
70 mm Stellweg/travel	LIMES 84N-70-HiSM-IMS	41.A89.07AVM	LIMES 84N-70-MiSM-IMS	41.A89.07BVM
120 mm Stellweg/travel	LIMES 84N-120-HiSM-IMS	41.A89.12AVM	LIMES 84N-120-MiSM-IMS	41.A89.12BVM
170 mm Stellweg/travel	LIMES 84N-170-HiSM-IMS	41.A89.17AVM	LIMES 84N-170-MiSM-IMS	41.A89.17BVM
270 mm Stellweg/travel	LIMES 84N-270-HiSM-IMS	41.A89.27AVM	LIMES 84N-270-MiSM-IMS	41.A89.27BVM

mit DC-Motor/with DC motor	mit Hall-Effekt-Endschaltern with Hall-effect limit switches		mit mechanischen Endschaltern with mechanical limit switches	
	Typ/type	Bestell-Nr./part no.	Typ/type	Bestell-Nr./part no.
45 mm Stellweg/travel	LIMES 84N-45-HiDS-IMS	41.A89.04GJM	LIMES 84N-45-MiDS-IMS	41.A89.04WJM
70 mm Stellweg/travel	LIMES 84N-70-HiDS-IMS	41.A89.07GJM	LIMES 84N-70-MiDS-IMS	41.A89.07WJM
120 mm Stellweg/travel	LIMES 84N-120-HiDS-IMS	41.A89.12GJM	LIMES 84N-120-MiDS-IMS	41.A89.12WJM
170 mm Stellweg/travel	LIMES 84N-170-HiDS-IMS	41.A89.17GJM	LIMES 84N-170-MiDS-IMS	41.A89.17WJM
270 mm Stellweg/travel	LIMES 84N-270-HiDS-IMS	41.A89.27GJM	LIMES 84N-270-MiDS-IMS	41.A89.27WJM

Zubehör/Accessories

Z-Montagewinkel für Lineartische LT (M) 80(F/M/P) und LIMES 84N	Z assembly bracket for series LT (M) 80(F/M/P) and LIMES 84N	MONT-LT(M) 80-Z	41.083.0001
Z-Montagewinkel für Lineartische LT (M) 80(F/M/P) und LIMES 84N bis 200 mm Stellweg	Z assembly bracket for series LT (M) 80(F/M/P) and LIMES 84N up to 200 mm travel	MONT-LT(M) 80-300-Z	41.083.0003
XY-Montagesatz für LIMES xxN, ohne Montage	XY assembly kit for LIMES xxN, without assembly	MONT-LIMES-xxN-XY	41.A89.0004
Anschlusskabel 3 m, geschirmt	connecting cable 3 m, shielded	KAB-09-HD26-3	53.20.D301
Fett für Spindel, 5 ml im Applikator	grease for spindle, 5 ml in applicator	SST.F11	90.999.0011
Anschlusskabel	connecting cable	OWIShop	